



CQB50W8 CMFC(D) SERIES 50 WATT 8:1 INPUT ISOLATED DC-DC CONVERTERS

Features

- Efficiency Up to 90%
- Fixed Switching Frequency
- Regulated Outputs
- Remote On/Off
- Low No Load Power Consumption
- Fully Protected (OTP/OCP/OVP/UVLO)
- 3000Vac I/O Isolation
- Operating Case Temperature -40 to +105°C
- UL 62368-1 2nd (Reinforce Insulation) Approval for DC Modules
- EN 50155 for EMC, Environmental and Characteristic
- Shock & Vibration EN 50155 (EN 61373) Compliant
- Fire & Smoke EN 45545-2 Compliant
- Safety Meets IEC/EN/UL 62368-1
- Build-In EMI Filter
- Chassis Mount, Baseplate Cooled



MODEL NUMBER	INPUT VOLTAGE	OUTPUT VOLTAGE	OUTPUT CURRENT		INPUT CURRENT		% EFF.	CAPACITOR LOAD MAX.
			MIN.	MAX.	NO LOAD	FULL LOAD		
CQB50W8-36S12□-CMFC CQB50W8-36S12□-CMFD	9.5-75 VDC	12 VDC	0 mA	4.17 A	10 mA	1544mA	90	8000µF
CQB50W8-36S15□-CMFC CQB50W8-36S15□-CMFD	9.5-75 VDC	15 VDC	0 mA	3.33 A	10 mA	1542mA	90	6800µF
CQB50W8-36S24□-CMFC CQB50W8-36S24□-CMFD	9.5-75 VDC	24 VDC	0 mA	2.08 A	12 mA	1541mA	90	2350µF
CQB50W8-36S28□-CMFC CQB50W8-36S28□-CMFD	9.5-75 VDC	28 VDC	0 mA	1.79 A	12 mA	1547mA	90	2350µF
CQB50W8-36S48□-CMFC CQB50W8-36S48□-CMFD	9.5-75 VDC	48 VDC	0 mA	1.05 A	12 mA	1556mA	90	700µF

NOTE:

1. Nominal Input Voltage 36 VDC.
2. □ = N or none
3. VR1 is Used for Output Voltage Adjustment.
4. Refer to Application Note for Thermal Resistance and Derating Information.
5. TVS is Included for Input Surge Voltage Protection.
6. Recommend an External Fuse for Input Reverse Polarity Protection (shunt diode is included inside).
7. Output connector CN3 wafer with TAIWAN KING PIN TERMINAL P110I series and mate with JST housing PH series or equivalent.
8. CN1 & CN2 connection: DINKLE EK500V-04P series or equivalent, suitable electric wire: 24~12AWG (IEC 0.5~2.5mm²).

PART NUMBER

Series	Nominal Input Voltage	Number of Outputs	Nominal Output Voltage	Remote On/Off Logic	Chassis Mount Type		Heatsink
CQB50W8-	II	O	XX	L	-YYY	Z	+WW
CQB50W8	36 : 36 VDC	S : Single	12 : 12VDC 15 : 15VDC 24 : 24VDC 28 : 28VDC 48 : 48VDC	None : Positive N : Negative	Chassis CMF : Mount Built in Filter	C : Open Frame D : With Cover	None : Blank HS : Heatsink HD : Heatsink+ Din Rail

Part Number Example:

CQB50W8-36S12N-CMFC: Chassis Mount, 50W, 8:1 9.5-75Vdc Input, Single 12Vdc Output, Negative Logic, Open Frame



CQB50W8 CMFC(D) Series

TECHNICAL SPECIFICATIONS

(All specifications are typical at nominal input, full load at 25°C unless otherwise noted.)

ABSOLUTE MAXIMUM RATINGS

PARAMETER	NOTES and CONDITIONS	Device	Min.	Typ.	Max.	Units
Input Voltage	Continuous	All	-0.3		75	V _{dc}
Input Surge Voltage	100ms max.	All			100	V _{dc}
Operating Case Temperature	At the center part of base plate	All	-40		105	°C
Storage Temperature		All	-40		105	°C

INPUT CHARACTERISTICS

PARAMETER	NOTES and CONDITIONS	Device	Min.	Typ.	Max.	Units	
Operating Input Voltage		All	9.5	36	75	V _{dc}	
Input Under Voltage Lockout							
Turn-On Voltage Threshold	Full load	All	8.4	8.8	9.3	V _{dc}	
Turn-Off Voltage Threshold	Full load	All	7.5	7.9	8.4	V _{dc}	
Lockout Hysteresis Voltage	Full load	All		0.9		V _{dc}	
Maximum Input Current	V _{in} =9.5V, Full load	All		7.5		A	
No-Load Input Current	V _{in} =36V, I _o =0A	See Model Number Table					mA

OUTPUT CHARACTERISTICS

PARAMETER	NOTES and CONDITIONS	Device	Min.	Typ.	Max.	Units
Voltage Set Point Accuracy	V _{in} =36V, Full load, T _c =25°C	All	-1.0		+1.0	%
Output Voltage Regulation						
Load Regulation	Full load to no load	All			±0.2	%
Line Regulation	V _{in} =High line to low line, full load	All			±0.2	%
Temperature Coefficient	T _c =-40°C to 105°C	All			±0.02	%/°C
Output Voltage Ripple and Noise (5Hz to 20MHz Bandwidth)						
Peak-to-Peak	Full load, 1uF ceramic capacitor	12V _o			150	mV
		15V _o			150	
		24V _o			240	
		28V _o			240	
		48V _o			480	
RMS.		12V _o			80	mV
		15V _o			80	
		24V _o			120	
		28V _o			120	
		48V _o			220	
Output Current Range	V _{in} = 9.5 to 75V	See Model Number Table				A
Over Current Protection	Hiccup mode. Auto recovery.	All	110	150	210	%
Short Circuit Protection		All	Continuous, Auto Recovery.			
External Load Capacitance	Full load (resistive)	See Model Number Table				uF
Output Voltage Trim Range	P _o ≤ max. rated power, I _o ≤ I _{o,max} .	All	-20		+15	%
Output Voltage Remote Sense Range	P _o ≤ max. rated power, I _o ≤ I _{o,max} . % of nominal V _o	All			+15	%
Over Voltage Protection	Limited voltage, % of nominal V _o	All	117	125	140	%

EFFICIENCY

PARAMETER	NOTES and CONDITIONS	Device	Min.	Typ.	Max.	Units
100% Load	V _{in} =36V	See Model Number Table				%



CQB50W8 CMFC(D) Series

DYNAMIC CHARACTERISTICS

PARAMETER	NOTES and CONDITIONS	Device	Min.	Typ.	Max.	Units
Output Voltage Current Transient						
Error Band	75% to 100% of I_{o_max} . step load change $dI/dt=0.1A/us$ (within 1% V_{out} nominal)	All			±5	%
Recovery Time		All			250	us
Turn-On Delay and Rise Time						
Full load (Constant resistive load)						
Turn-On Delay Time, From On/Off Control	$V_{on/off}$ to 10% V_{o_set} , Remote on	All		20		ms
Turn-On Delay Time, From Input	$V_{in_min.}$ to 10% V_{o_set} , Power up	All		20		ms
Output Voltage Rise Time	10% V_{o_set} to 90% V_{o_set}	All		10		ms

ISOLATION CHARACTERISTICS

PARAMETER	NOTES and CONDITIONS	Device	Min.	Typ.	Max.	Units
Isolation Voltage (100% factory Hi-Pot tested @2sec.)	1 Minute; input to output	All			3000 4200	V_{ac} V_{dc}
	1 Minute; input to case (base plate)				2100 3000	V_{ac} V_{dc}
	1 Minute; output to case (base plate)				1500 2100	V_{ac} V_{dc}
Isolation Resistance	Input to output	All	100			MΩ
Isolation Capacitance	Input to output	All		15000		pF
	Input to case (base plate)			16000		
	Output to case (base plate)			23000		

FEATURE CHARACTERISTICS

PARAMETER	NOTES and CONDITIONS	Device	Min.	Typ.	Max.	Units
Switching Frequency	Pulse width modulation (PWM), fixed	All	180	200	220	KHz
On/Off Control, Positive Remote On/Off Logic, Refer to -Vin Pin						
Logic Low (Module Off)	$V_{on/off}$ at $I_{on/off}=1.0mA$	All	0		1.0	V
Logic High (Module On)	$V_{on/off}$ at $I_{on/off}=0.0uA$, Pin open=on	All	4.0		75	V
On/Off Control, Negative Remote On/Off Logic, Refer to -Vin Pin						
Logic High (Module Off)	$V_{on/off}$ at $I_{on/off}=0.0uA$, Pin open=off	All	4.0		75	V
Logic Low (Module On)	$V_{on/off}$ at $I_{on/off}=1.0mA$	All	0		1.0	V
On/Off Current (for Both Remote On/Off Logic)	$I_{on/off}$ at $V_{on/off}=0V$	All		0.3	1	mA
Leakage Current (for Both Remote On/Off Logic)	Logic high, $V_{on/off}=15V$	All			30	uA
Off Converter Input Current	Shutdown input idle current	All		5	10	mA
Over Temperature Shutdown	Temperature at the center part of base plate, non-latching	All		110		°C
Over Temperature Recovery		All		100		°C

GENERAL SPECIFICATIONS

PARAMETER	NOTES and CONDITIONS	Device	Min.	Typ.	Max.	Units
MTBF	$I_o=100\%$ of $I_{o_max.}$; MIL-HDBK - 217F_Notice 1, GB, 25°C	36S12		561		K hours
		36S15		612		
		36S24		612		
		36S28		603		
		36S48		610		
Weight		-CMFC		215		grams
		-CMFD		250		
		-CMFD+HS		470		
		-CMFD+HD		490		



CQB50W8 CMFC(D) Series

GENERAL SPECIFICATIONS

Shock/Vibration	EN 50155 (EN 61373) Compliant		
Humidity	95% RH max. Non Condensing		
Altitude	5000m Operating Altitude, 12000m Transport Altitude		
Thermal Shock	MIL-STD-810F		
Fire & Smoke	EN 45545-2 Compliant		
EMI	EN 55032 & EN 50155 Compliant		Class A
ESD	EN 61000-4-2	Level 3: Air ± 8 kV, Contact ± 6 kV	Perf. Criteria A
Radiated Immunity	EN 61000-4-3	Level 3: 80~1000MHz, 20V/m	Perf. Criteria A
Fast Transient	EN 61000-4-4	Level 3: On power input port, ± 2 kV	Perf. Criteria A
Surge	EN 61000-4-5	Level 4: Line to earth, ± 4 kV, Line to line, ± 2 kV	Perf. Criteria A
Conducted Immunity	EN 61000-4-6	Level 3: 0.15~80MHz, 10V	Perf. Criteria A
Interruptions of Voltage Supply	EN 50155	Class S3: 20ms interruptions	Perf. Criteria A
Supply Change Over	EN 50155	Class C2: During a supply break of 30 ms	Perf. Criteria A
Application Note Link	CQB50W8-36S CMFC(D) Series App Notes		
Packaging Information Link	Packaging Information		

Immunity to Environmental Conditions

Phenomenon	EN 50155; 2017 Reference Clause(s)	Reference Standard	Test Conditions	Result
Low Temperature Start-up test	13.4.4	EN 60068-2-1	Class OT6 Temperature: -40°C Duration: 2 hrs	Pass
Dry Heat Test	13.4.5	EN 60068-2-2	Class OT6 & ST2 Temperature: 85°C Duration: 6 hrs Extended temperature: 100°C Extended Duration: 10min	Pass
Low Temperature Storage Test	13.4.6	EN 60068-2-1	Temperature: -40°C Duration: 16 hrs	Pass
Cyclic Damp Heat Test	13.4.7	EN 60068-2-30	Temperature: 25°C - 55°C Humidity: 90% RH Duration: 48 hrs	Pass
Random Vibration Test	13.4.11	EN 61373	Temperature: 25°C \pm 10°C Humidity: 50% \pm 25% RH Frequency range: 5 ~ 150 Hz Vertical: 1.01 m/s^2 Transverse: 0.450 m/s^2 Longitudinal: 0.700 m/s^2 Duration: 10 min / axis	Pass
Simulated Long Life Test at Increased Random Vibration Levels	13.4.11	EN 61373	Temperature: 25°C \pm 10°C Humidity: 50% \pm 25% RH Frequency range: 5 ~ 150 Hz Vertical: 5.72 m/s^2 Transverse: 2.55 m/s^2 Longitudinal: 3.96 m/s^2 Duration: 5 hrs / axis	Pass
Shock Test	13.4.11	EN 61373	Temperature: 25°C \pm 10°C Humidity: 50% \pm 25% RH Frequency range: 5 ~ 150 Hz \pm Vertical: 30 m/s^2 \pm Transverse: 30 m/s^2 \pm Longitudinal: 50 m/s^2 Duration: 30ms x18 (Each axis 3 shocks)	Pass



CQB50W8 CMFC(D) Series

EN 45545-2 Fire & Smoke Test Conditions

Item		Standard	Hazard Level
R22	Oxygen Index Test	EN 45545-2: 2013+A1:2015 EN ISO 4589-2: 2017	HL1, HL2, HL3
	Smoke Density Test	EN 45545-2: 2013+A1:2015 EN ISO 5659-2: 2017	HL1, HL2, HL3
	Smoke Toxicity Test	EN 45545-2: 2013+A1:2015 NF X70-100-1 and -2: 2006	HL1, HL2, HL3
R23	Oxygen Index Test	EN 45545-2: 2013+A1:2015 EN ISO 4589-2: 2017	HL1, HL2, HL3
	Smoke Density Test	EN 45545-2: 2013+A1:2015 EN ISO 5659-2: 2013	HL1, HL2, HL3
	Smoke Toxicity Test	EN 45545-2: 2013+A1:2015 NF X70-100-1 and -2: 2006	HL1, HL2, HL3
R24	Oxygen Index Test	EN 45545-2: 2013 EN ISO 4589-2	HL1, HL2, HL3
R25	Glow - Wire Test	EN 45545-2+A1:2016 EN 60695-2-11:2014	HL1, HL2, HL3
R26	Vertical Flame Test	EN 45545-2: 2013 EN 60695-11-10: 2013	HL1, HL2, HL3

CHARACTERISTIC CURVE

Power Derating Curve

CQB50W8-36SXX-CMFC(D) Derating Curve with Heat Sink (Vin=36V)

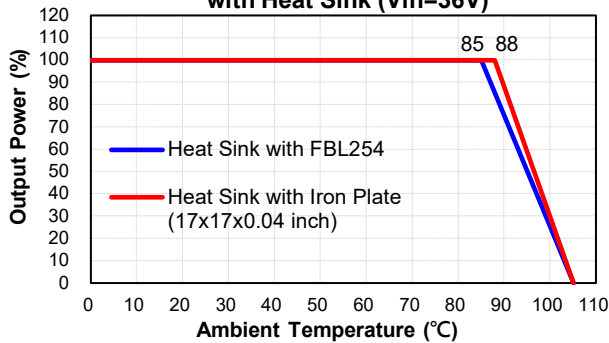

CQB50W8-36SXX-CMFD+HS(HD) Derating Curve (Vin=36V)

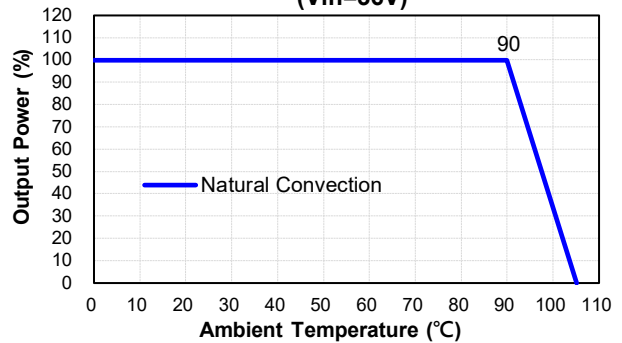

Performance Data

CQB50W8-36S12-CMFC Eff Vs Io @25 Deg. C

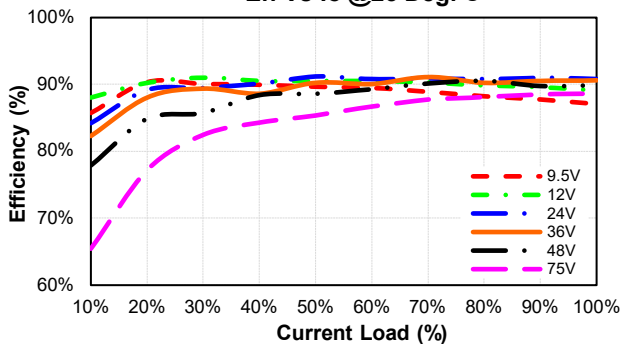

CQB50W8-36S12-CMFC Pd Vs Po @25 Deg. C

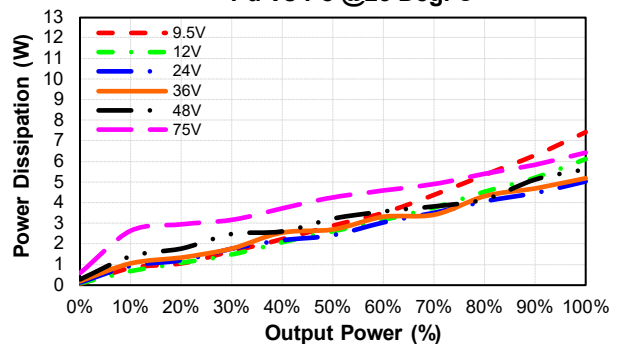



CQB50W8 CMFC(D) Series

CQB50W8-36S15-CMFC
Eff Vs Io @25 Deg. C

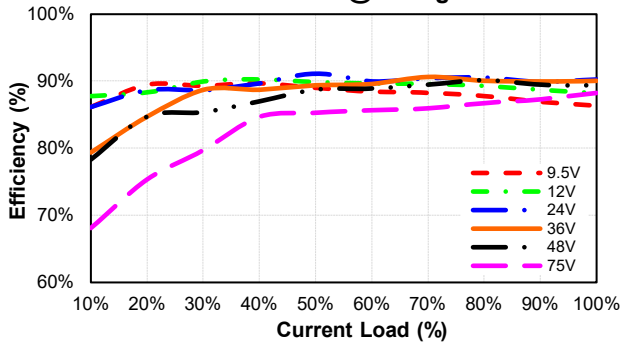

CQB50W8-36S15-CMFC
Pd Vs Po @25 Deg. C

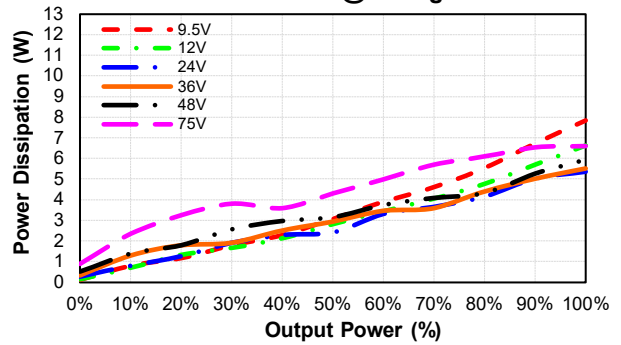

CQB50W8-36S24-CMFC
Eff Vs Io @25 Deg. C

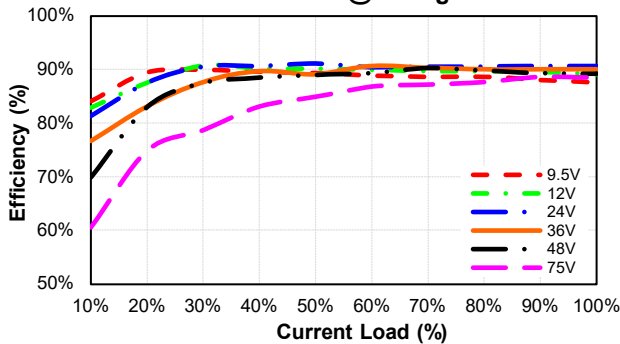

CQB50W8-36S24-CMFC
Pd Vs Po @25 Deg. C

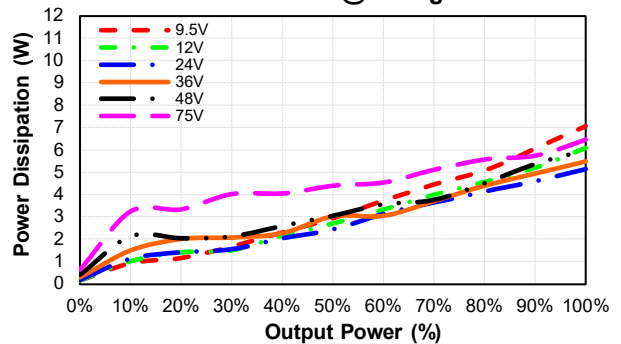

CQB50W8-36S28-CMFC
Eff Vs Io @25 Deg. C

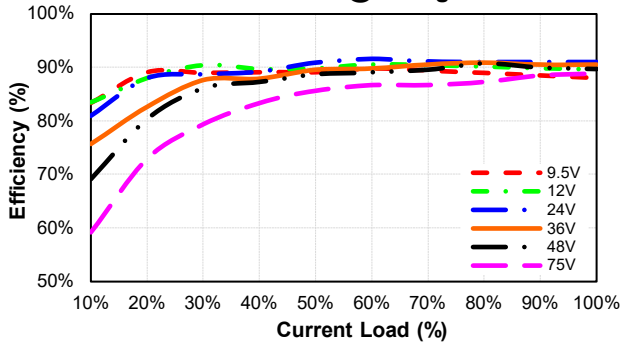

CQB50W8-36S28-CMFC
Pd Vs Po @25 Deg. C

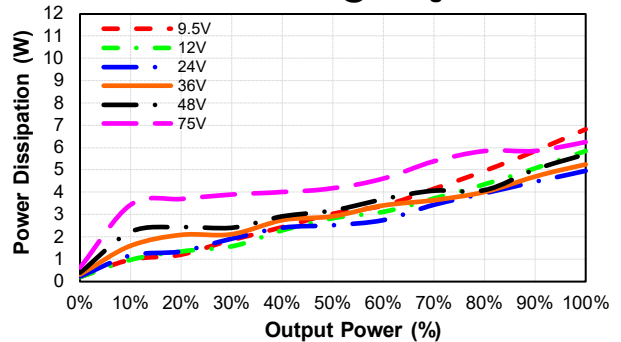

CQB50W8-36S48-CMFC
Eff Vs Io @25 Deg. C

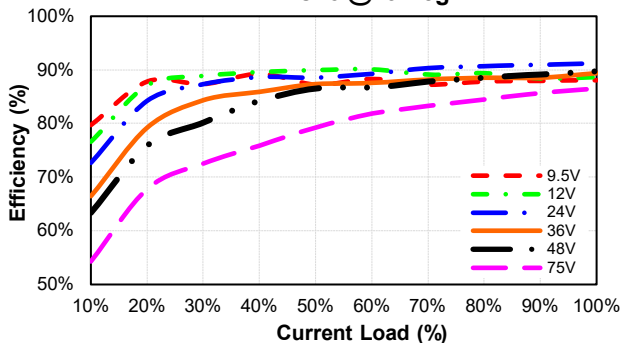

CQB50W8-36S48-CMFC
Pd Vs Po @25 Deg. C

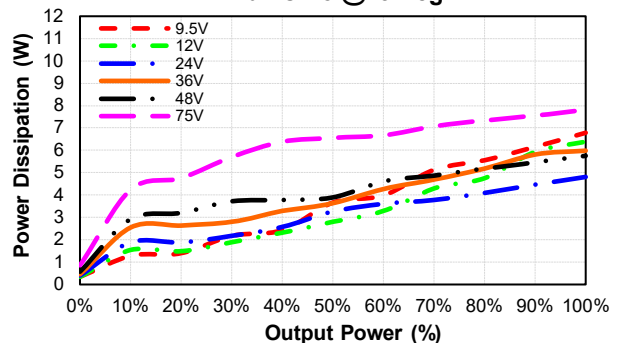



CQB50W8 CMFC(D) Series

MECHANICAL SPECIFICATION

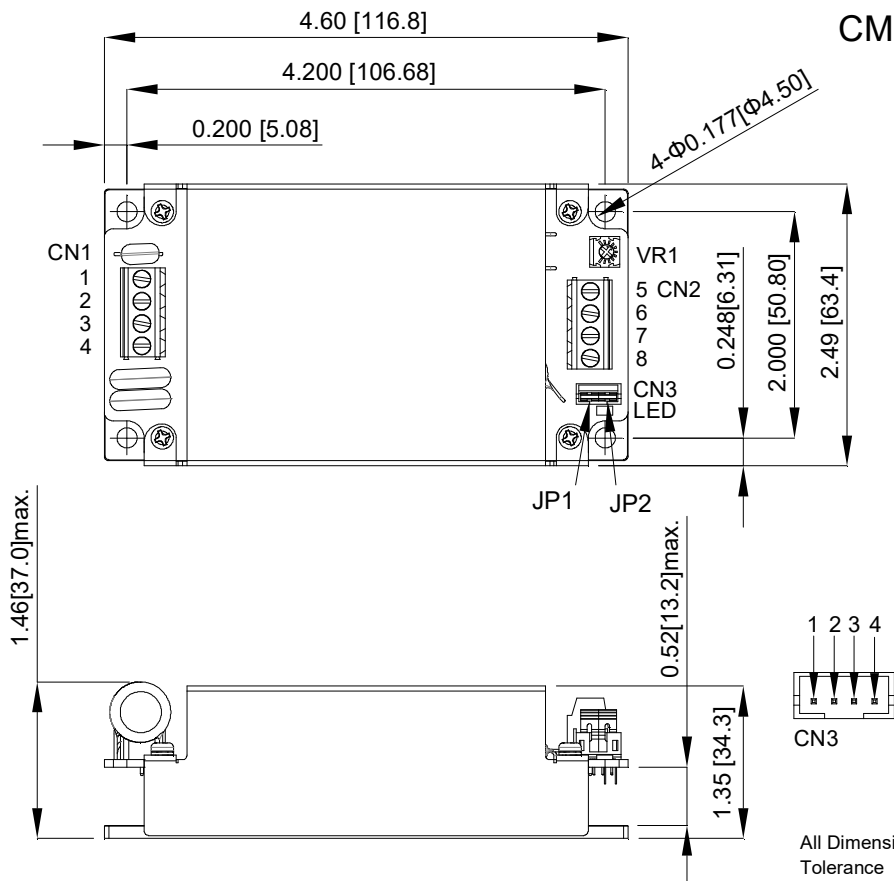
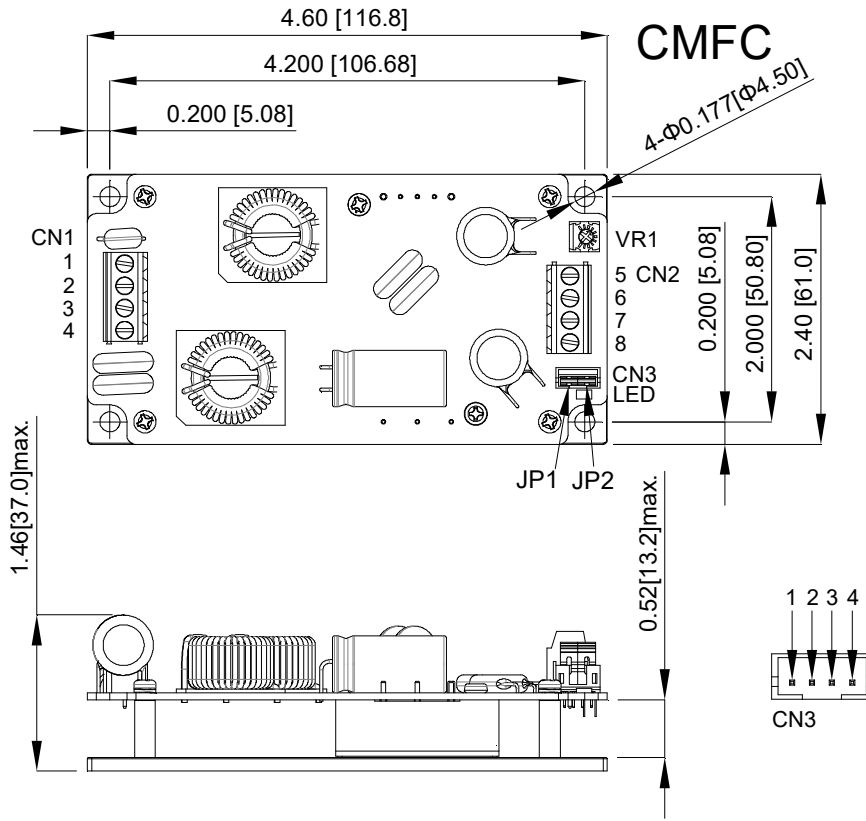

CMFD with Cover

CN1 & CN2 PIN CONNECTION

PIN	Function
1	+V Input
2	-V Input
3	Remote
4	Case
5	+V Output
6	+V Output
7	-V Output
8	-V Output

CN3 PIN CONNECTION

PIN	Function
1	-V Output
2	-Sense
3	+Sense
4	+V Output

*JP1: Short PIN1 & PIN2
*JP2: Short PIN3 & PIN4

All Dimensions in Inches[mm]

Tolerance Inches: x.xx=±0.02, x.xxx=±0.010
Millimeters: x.x=±0.5, x.xx=±0.25



CQB50W8 CMFC(D) Series

MECHANICAL SPECIFICATION

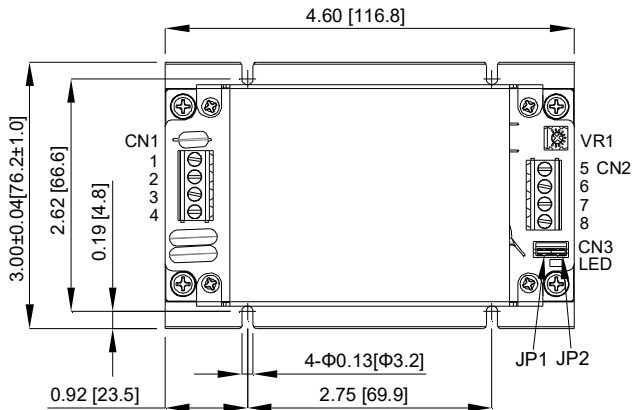

CMFD+HS

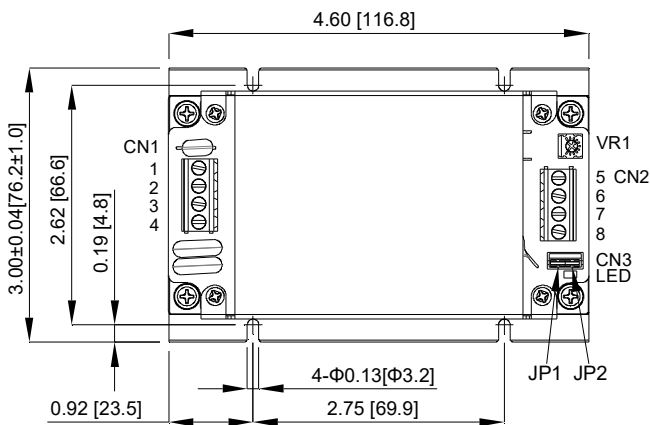
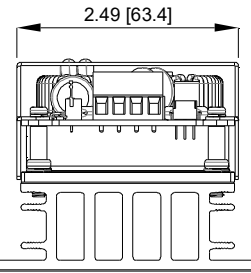
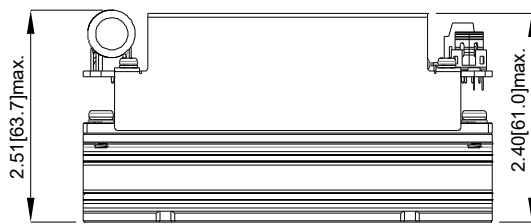
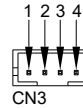

CMFD+HD

All Dimensions in Inches[mm]
 Tolerance Inches: x.xx=±0.02, x.xxx=±0.010
 Millimeters: x.x=±0.5, x.xx=±0.25

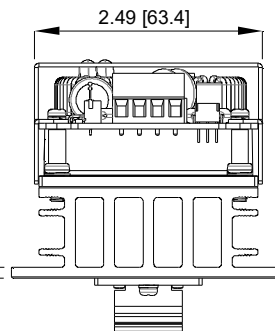
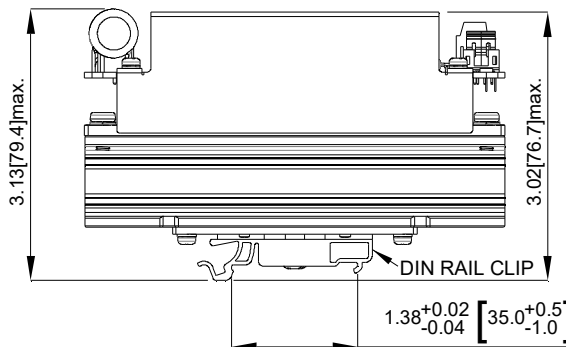
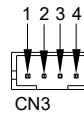

CN1 & CN2 PIN CONNECTION

PIN	Function
1	+V Input
2	-V Input
3	Remote
4	Case
5	+V Output
6	+V Output
7	-V Output
8	-V Output

CN3 PIN CONNECTION

PIN	Function
1	-V Output
2	-Sense
3	+Sense
4	+V Output

*JP1: Short PIN1 & PIN2
 *JP2: Short PIN3 & PIN4

CINCON Electronics Co. Ltd.
 Add: 14F, No. 306, Sec.4, Hsin Yi Rd., Taipei, Taiwan
 Tel: 886-2-27086210
 Fax: 886-2-27029852
 E-mail: sales@cincon.com.tw
 Web: www.cincon.com